

	Value	Unit
	-30	V
	-1.6	V
	-55	A
	6.1	mΩ
$R_{DS(ON_Typ)}(@V_{GS}=-4.5V)$	8.9	mΩ

Ordering Information

Device	Marking	MSL	Form	Package	Reel(pcs)	Per Carton (pcs)
JMTK100P03A	JMTK100P03A	3	Tape&Reel	TO-252-3L	2500	25000

Absolute Maximum Ratings (@ $T_C = 25^\circ\text{C}$ unless otherwise specified)

Symbol	Unit
V_{DS}	V
V_{GS}	V
I_{DM}	A
E_{AS}	mJ
T_{J_STG}	$^\circ\text{C}$

$T_C = 25^\circ\text{C}$
 $T_C = 100^\circ\text{C}$

Thermal Characteristics

Symbol	Parameter	Max	Unit
R	Thermal Resistance, Junction to Ambient ⁽³⁾	41	$^\circ\text{C/W}$
R	Thermal Resistance, Junction to Case	2.9	

Electrical Characteristics ($T_J = 25^\circ\text{C}$ unless otherwise specified)

Symbol	Conditions	Min.	Typ.	Max.	Unit
Off Characteristics					
$V_{(BR)DSS}$		-30	-	-	V
I_{DSS}		-	-	-1.0	μ
I_{GSS}		-	-	± 100	
On Characteristics					
$V_{GS(th)}$		-1.1	-1.6	-2.5	V
		-	6.1	10.0	m Ω
		-	8.9	16.0	m Ω
R_g		-	5.6	-	Ω
C_{iss}		2489	3485	4705	pF
C_{oss}		283	397	536	pF
C_{rss}		240	336	454	pF
Q_g		44	62	83	nC
Q_{gs}		7	10	13	nC
Q_{gd}		9	12	16	nC
Switching Characteristics					
$t_{d(on)}$		-	16	-	ns
t_r		-	62	-	ns
$t_{d(off)}$		-	55	-	ns
t_f		-	70	-	ns
Static Characteristics					
I_S		-	-	-55	A
I_{SM}		-	-	-221	A
V_{SD}		-	-	1.2	V
t_{rr}		15	22	29	ns
Q_{rr}		-	11.5	-	nC

- Notes:
1. Repetitive Rating: Pulse Width Limited by Maximum Junction Temperature.
 2. E_{AS} condition: Starting $T_J=25^\circ\text{C}$, $V_{DD}=-15\text{V}$, V

Typical Performance Characteristics

Typical Performance Characteristics

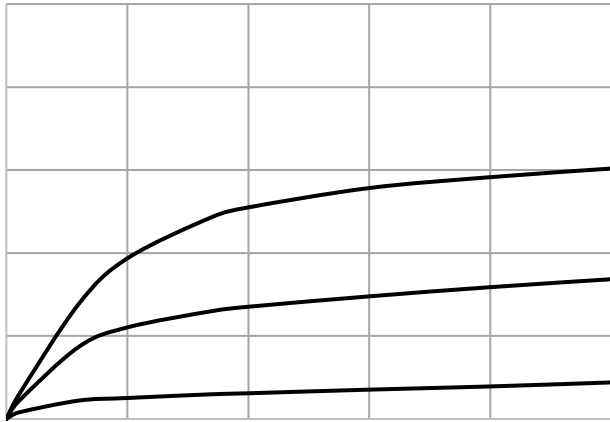



Typical Performance Characteristics

Figure 11: Normalized Breakdown voltage vs. Junction Temperature

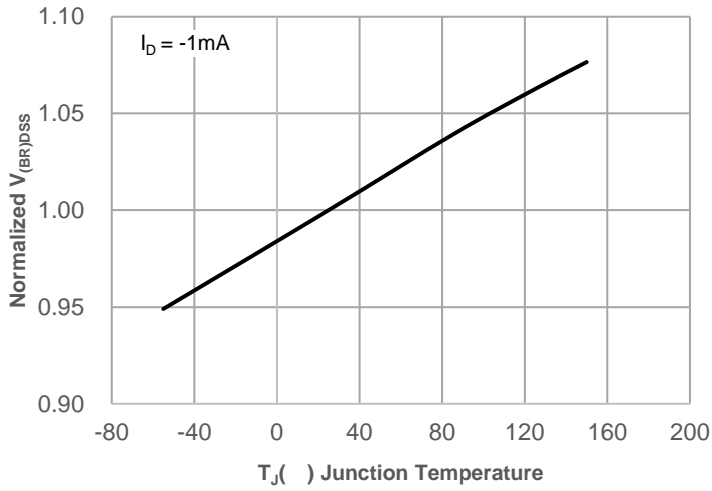

Figure 12: Normalized on Resistance vs. Junction Temperature

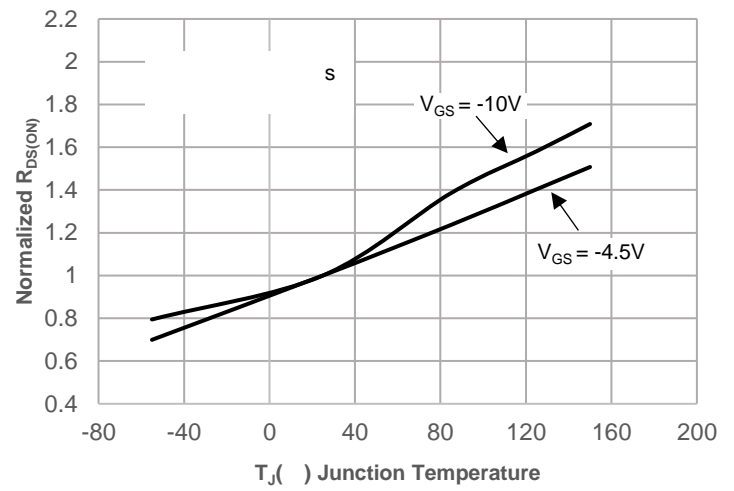

Figure 13: Normalized Threshold Voltage vs. Junction Temperature

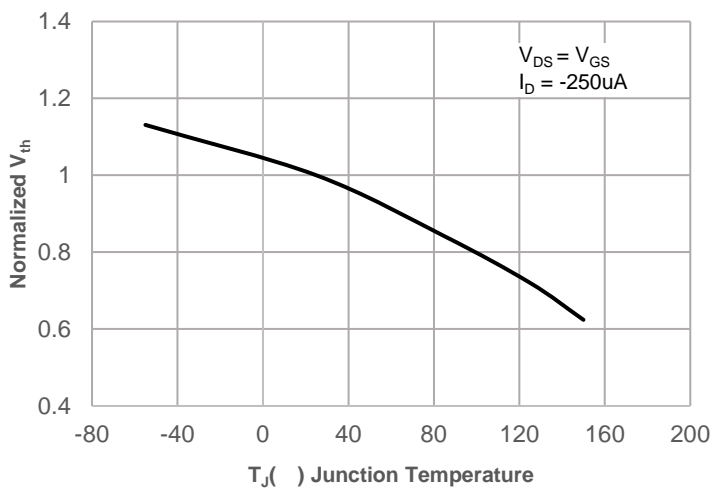

Figure 14: $R_{DS(ON)}$ vs. V_{GS}

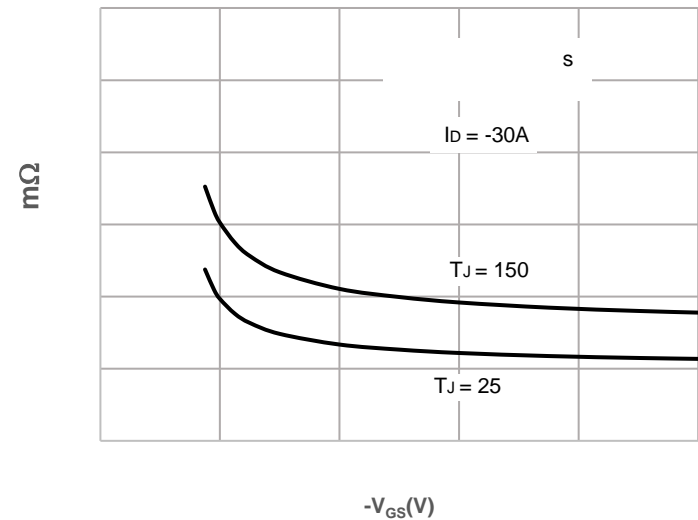
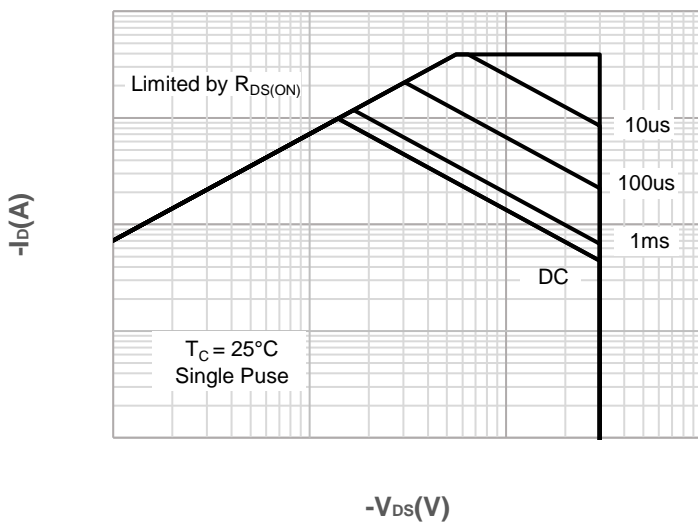

Figure 15: Maximum Safe Operating Area



Test Circuit



Figure 1: Gate Charge Test Circuit & Waveform

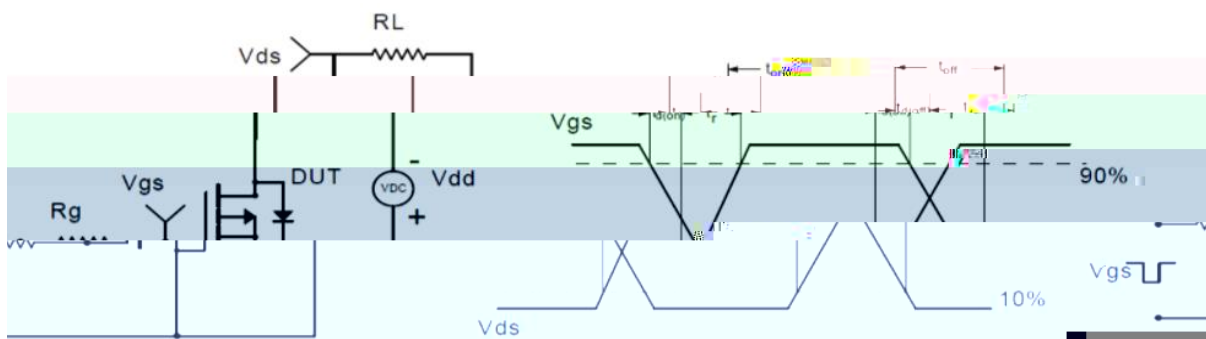

Figure 2: Resistive Switching Test Circuit & Waveform

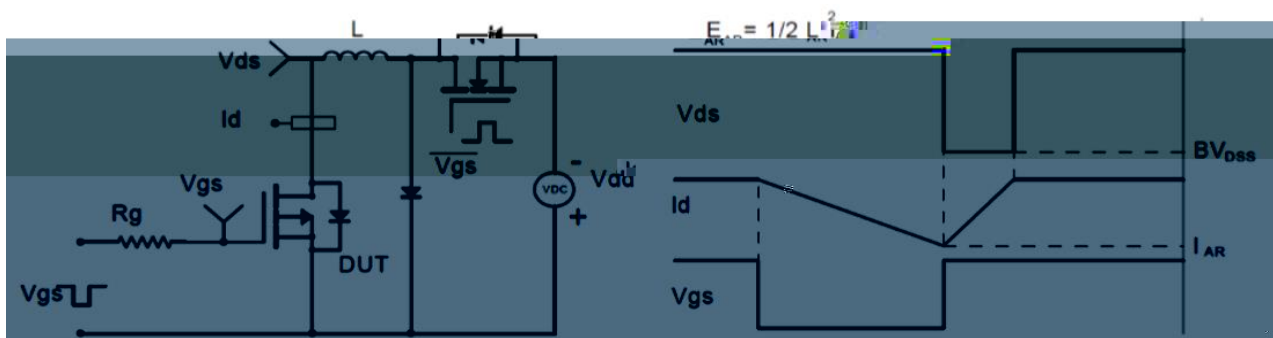

Figure 3: Unclamped Inductive Switching Test Circuit & Waveform

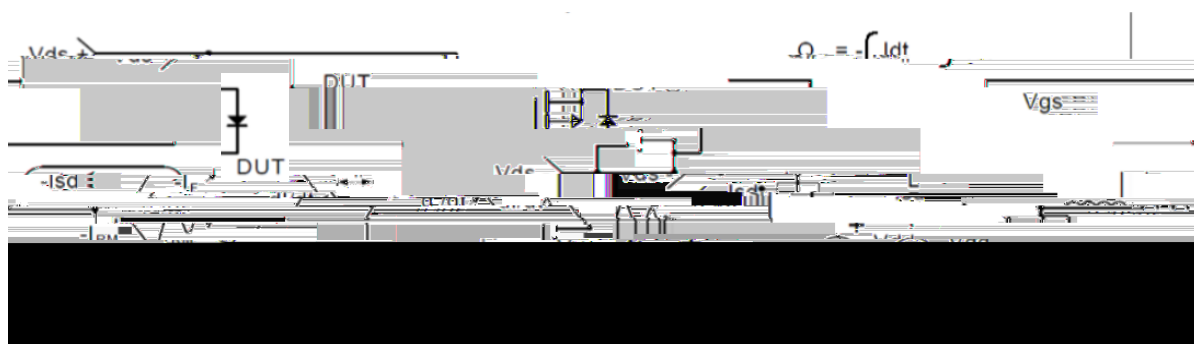

Figure 4: Diode Recovery Test Circuit & Waveform



Package Mechanical Data(TO-252-3L)